

Art. Nr. 2838596
1/6



03.04.2024

Art. Nr. 2838596

Groundplan - Grundplan - Plan de masse - Planimetria - Plattegrond - Planimetría -
Põhiplaan

590

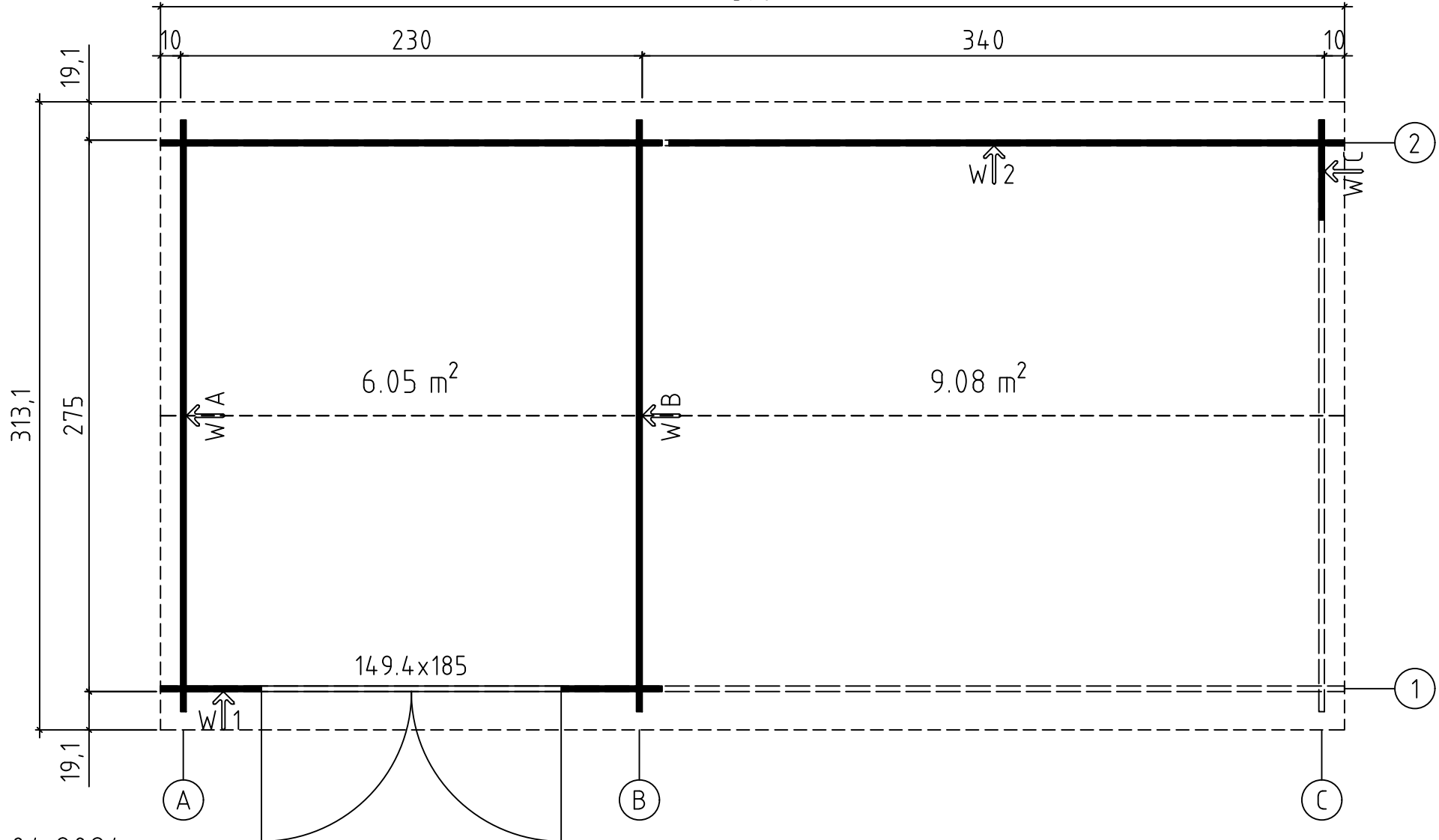







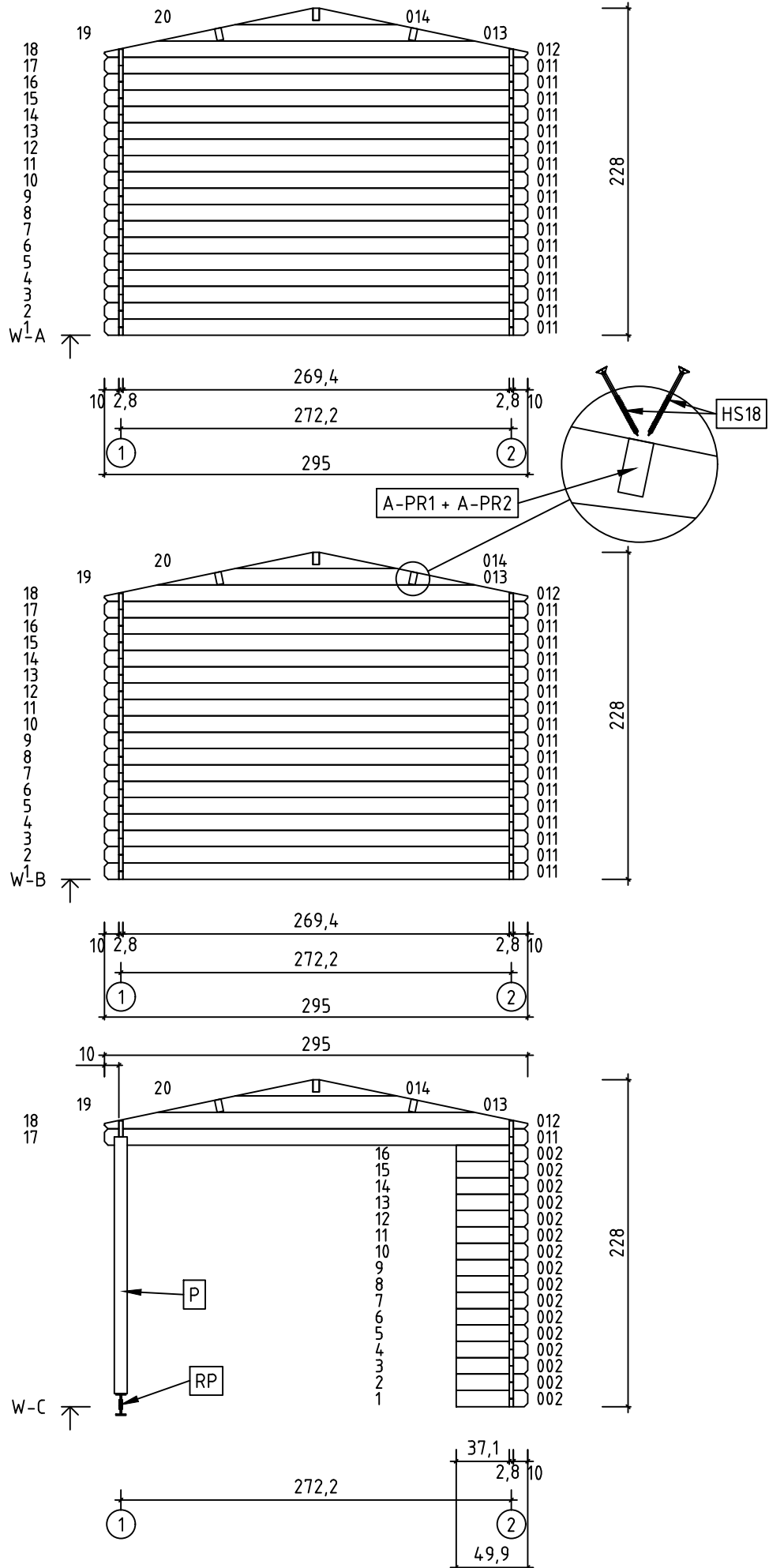



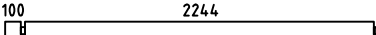
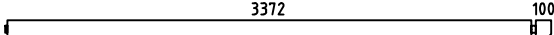
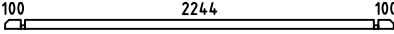
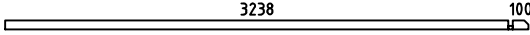
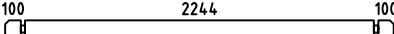
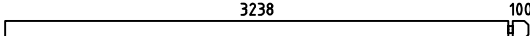
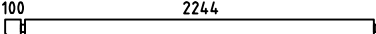
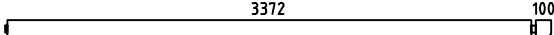
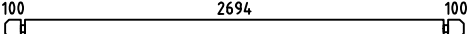
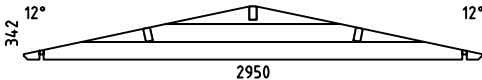
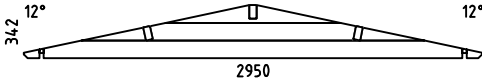
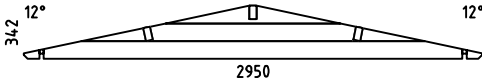
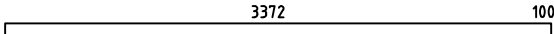
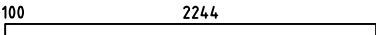

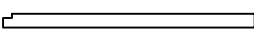

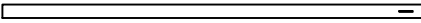

03.04.2024

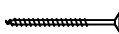
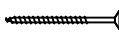
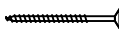
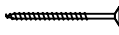
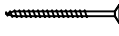
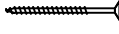
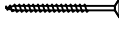
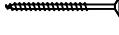



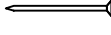
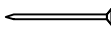
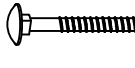

2/6

Art. Nr. 2838596

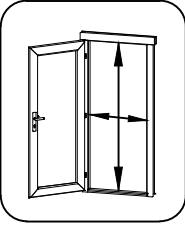
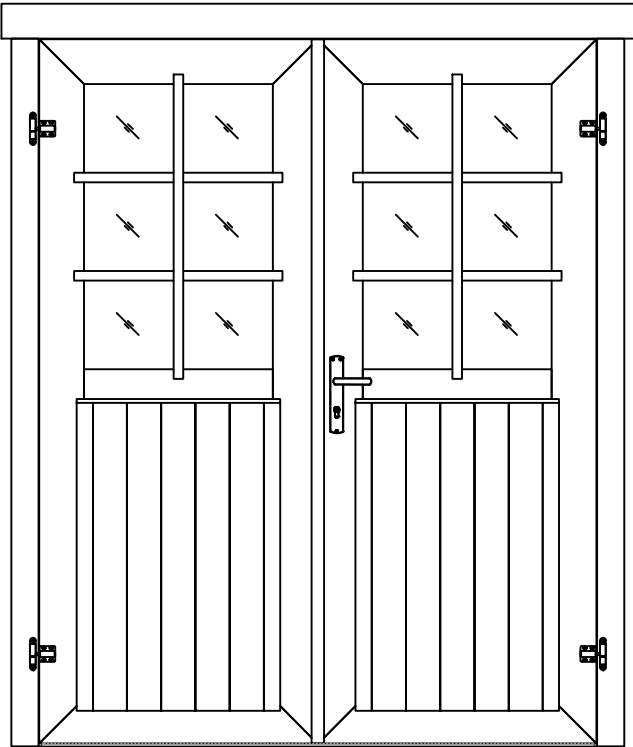

Pos	03.04.2024 Piece list - Stückliste - Liste des pièces - Elementi - Stuklijst - Elementos - Tükítabel Art. Nr. 2838596	5/6	Q	P (mm)	L (mm)
001 931			2	28x57	499
002 932			48	28x114	499
003 34999			1	28x114	2386
004 35002			1	28x114	3514
005 928			1	28x57	2500
006 34517			1	28x57	3366
007 929			16	28x114	2500
008 34518			16	28x114	3366
009 35001			1	28x114	2386
010 35000			1	28x114	3514
011 10854			35	28x114	2950
WA-1 35003			1		
WB-1 35003			1		
WC-1 35003			1		
A-PR2 34521	Roof beam - Dachbalken - Panne de toit - Perlina del tetto - Gordingen / dakbalk - Correa - Pärlin 		3	44x146	3514
A-PR1 34522	Roof beam - Dachbalken - Panne de toit - Perlina del tetto - Gordingen / dakbalk - Correa - Pärlin 		3	44x146	2386
RB-1 14993	Roof boards - Dachbretter - Voliges - Perlina per tetto - Dakhout - Tablero de tejado - Katuselaud 		132	90x15.5	1600
DPL-1 22389	Roofing felt fillet - Dachpappenleiste - Baguette de fixation du feutre bitumeux - Asse per fissaggio guaina bituminosa - Afdeklijst asfaltpapier - Moldura de fieltro para tejado - Katusepapiliist 		4	15x45	1650
P 36570	Post - Pfosten - Poteau - Piede registrabile - Stijl - Poste - Post 		1	90x90	1780
DRV-1 28958	Roof edge reinforcement - Dachrandverstärkung - Corniere de renfort de bord de toit - Rinforzo x tetto - Dakrand versterking - Refuerzo de aleros - Räästatugevdus 		4	15x45	2950
HP-1 35004	H-profile - H-profiils - Profile H - Profilo ad H - H-profiel - Perfil en H - H-profiil 		1	58x90	1935

Pos	Piece list - Stückliste - Liste des pièces - Elementi - Stuklijst - Elementos - Tükítabel 03.04.2024 Art. Nr. 2838596 6/6	Q	P (mm)	L (mm)
KFS-1 2249	Storm protection - Sturmleiste - Latte anti-tempete - Protezione anti vento - Stormverankering / beveliging - Moldura antitormenta - Tormikinnitusliist 	5	22x45	2050
UT-1 34526	U-profile - U-profils - Profile u - Profilo ad u - U-profiel - Perfil en U - U-profiil 	1	28x58	1780
GL-1 35005	Gable moulding - Giebelleiste - Planche de rive - Finitura per frontale e retro del tetto - Gevellijst - Tablero de frontón - Viilulaud 	4	15x120	1650
HS8 5105	Screw for gable segment - Schrauben für deckblatt - Vis pour fixation losange de finition - Viti x frontali tetto - Schroef voor gevelpunt segment - Tornillo para rombo - Kruvi rombile 	4	3.5x35	
HS9 5106	Screw for u-profile - Schraube zur befestigung u-profils - Vis a tete fraisée pour profil u - Vite per profilo ad u - Schroef ter bevestiging u-profiel - Tornillo para perfil en U - Kruvi U-profiilile 	6	3.5x50	
HS9 5106	Screw for gable moulding - Schrauben für giebelleiste - Vis pour fixation planche de rive - Vite per fissare finiture davanti e dietro del tetto - Schroef voor gevellijst - Tornillo para tablero de frontón - Kruvi viilulauale 	24	3.5x50	
HS4 5102	Screw for roof edge reinforcement - Schrauben für dachrandverstärkung - Vis pour fixation corniere renfort de bord de toit - Viti x rinforzo bordo tetto - Schroef voor dakrand versterking - Tornillo para refuerzo de alero - Kruvi räästatugevduse 	28	3x30	
HS14 5111	Screw for post - Schrauben für pfosten - Vis de fixation des poteaux - Viti per inviare - Schroef voor stijlen - Tornillo para poste - Kruvi postile 	2	4.5x80	
HS18 5113	Screw for roof beams - Schrauben für dachbalken - Vis pour fixation pannes de toit - Viti per perline del tetto - Schroef voor gordingen / dakbalken - Tornillo para correas - Kruvi pärlinitele 	12	5x120	
HS18 5113	Screw for wall details - Schraube für wand details - Vis pour mur details - Viti per elementi della porta - Schroef voor wand details - Tornillo para elementos de pared - Kruvi seinadetaildele 	4	5x120	
HS18 5113	Screw for gable - Schrauben für giebel - Vis pour fixation des pignons - Viti per timpano - Schroef voor gevelpunt - Tornillo para fijación de frontones - Kruvi viilude kinnitamiseks 	6	5x120	
HS20 5118	Screw for post height adjustment - Schrauben für regulierungsschraube für pfosten - Vis de fixation de support réglable de poteau - Viti per fissare ed aggiustare l'altezza del palo verticale - Schroef voor hoogte instelling stijlen - Tornillo para anclaje - Kruvi vajumispidile 	8	6x50	
SH28 32509	Hammer block - Schlagholz - Calle de frappe - Blocco di legno da usare come cuscinetto quando si usa il martello - Slagklos - Bloque de impacto - Löögiklots 	1		
SFS 5133	Nut for storm protection - Schraubenmutter für sturmleiste - Erou pour latte anti-tempete - Dado x asta protezone vento - Moer voor stormverankering - Tuerca para moldura antitormenta - Mutter tormikinnitusliistule 	10	D6	
NF4 5137	Zn nail for roof - Zn nägel für dachbretter - Pointe pour fixation voliges de toit - Chiodi x perline tetto - Spijker(nagel) voor dakhout - Clavo para tablero de tejado - Nael katuselauale 	414	2x50	
NF5 5145	Zn nail for roofing felt fillet - Zn nägel für dachpappenleiste - Pointe pour baguette de fixation feutre bitumeux - Chiodi x carta bituminosa x tetto - Spijker(nagel) voor asfaltpapier afdekljst - Clavo de moldura de fieltro - Papiliistunael 	16	2x40	
BFS 5155	Bolt for storm protection - Bolzen für sturmleiste - Boulon pour latte anti-tempete - Bullone x asta protezone vento - Bout voor stormankerlat - Perno de madera para moldura antitormenta - Puidupolt tormikinnitusliistule 	10	6x60	
GS 32614	Gable segment - Deckblatt - Losange de finition - Decorazione in legno x frontale tetto - Gevelpunt segment - Rombo - Romb 	2		
DFS 5125	Washer for storm protection - Dichtscheibe für sturmleiste - Rondelle pour latte anti-tempete - Rondella x asta protezone vento - Afdichtring voor storm strip - Arandela para moldura antitormenta - Seib tormikinnitusliistule 	10	D6	
RP 34582	Post height adjustment - Pfostenträger verstellbar - Support réglable de poteau - Piede registrabile in altezza - Stelschroef voor stijlpot - Anclaje - Vajumispolt 	1	D20	
23270	Door - Tür - Porte - Porte - Deur - Puerta - Uks 14.94x1850 TUK.2.056.SVP.MMX28 SGA+28	1		

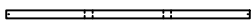
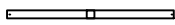
Pos	19.12.2017	Piece list - Stückliste - Liste des pièces - Elementi - Stuklijst - Tükítabel 14 94x1850 TUK.2.056.SVP.MMX28 SGA+28	1/2	Q	P (mm)	L (mm)
Glass size - Glasgröße - Taille de la vitre - Misura del vetro - Glas afmeting - Klaasi mõõt: 502x750 mm				 <p>1418x1794 mm</p>		
						
1	Upper door jamb - Türrahmen oben - Cadre de porte supérieur - Telaio superiore della porta - Bovendorpel - Ukse ülemine leng			1	66x100	1438
2	Left door jamb - Türrahmen links - Cadre de porte gauche - Telaio montante sinistro della porta - Linkerstijl deurframe - Ukse vasak leng			1	66x80	1850
3	Right door jamb - Türrahmen rechts - Cadre de porte droit - Telaio montante destro della porta - Rechterstijl deurframe - Ukse parem leng			1	66x80	1850
4	Doorstep - Swelle - Barre de seuil - Soglia della porta - Deurdorpel - Lävepakk			1	20x21	1418
5	Connection strip - Deckleiste - Baguette de battement - Profilo verticale della porta - Stulplijst - Kokkuvältsiliist			1	13x32	1812
6	Georgian bars - Sprossen - Croisillons - La griglia georgiana - Raamverdeling - Petteliistud			2	15x25	784
7	Georgian bars - Sprossen - Croisillons - La griglia georgiana - Raamverdeling - Petteliistud			4	15x25	536

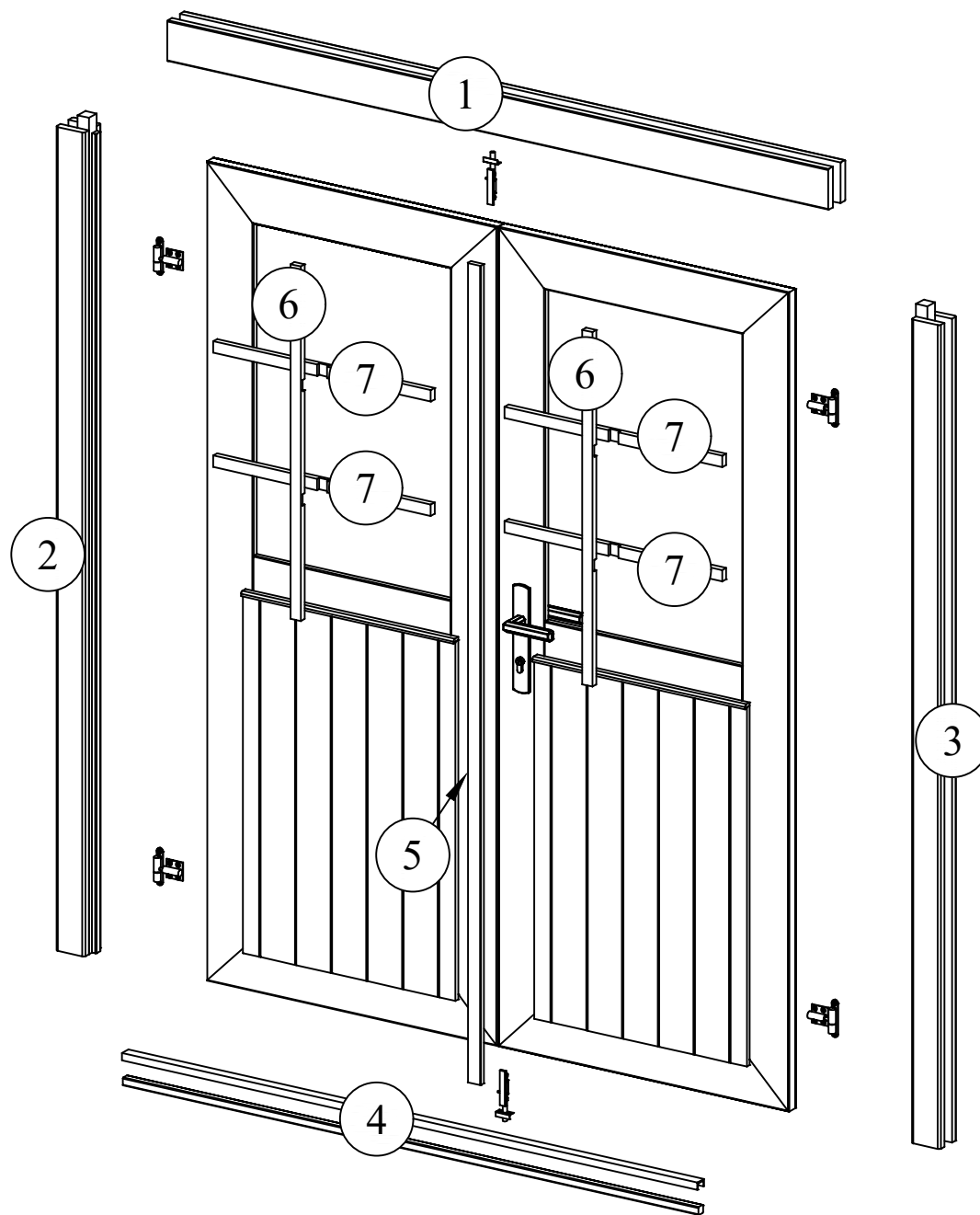

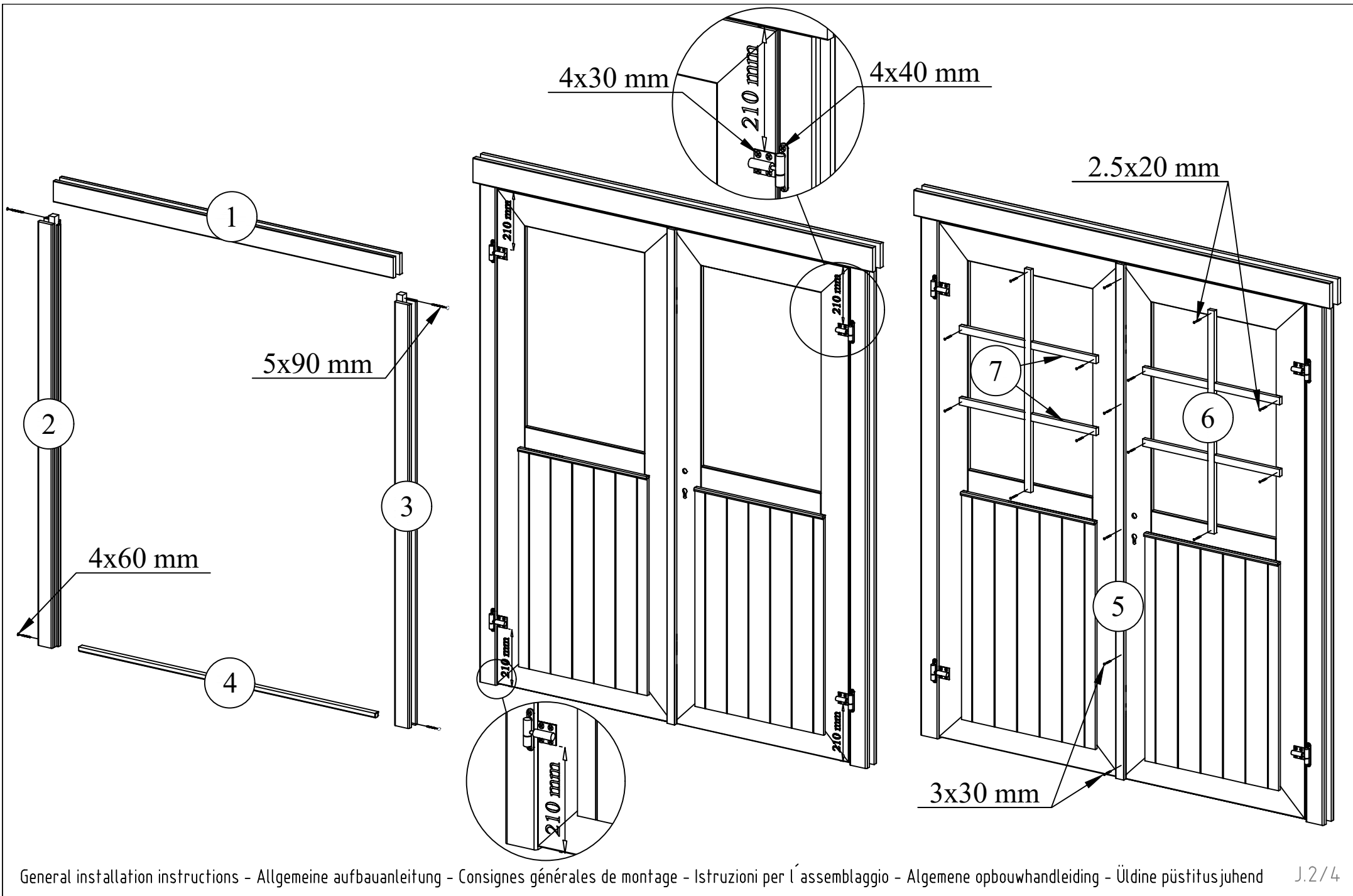

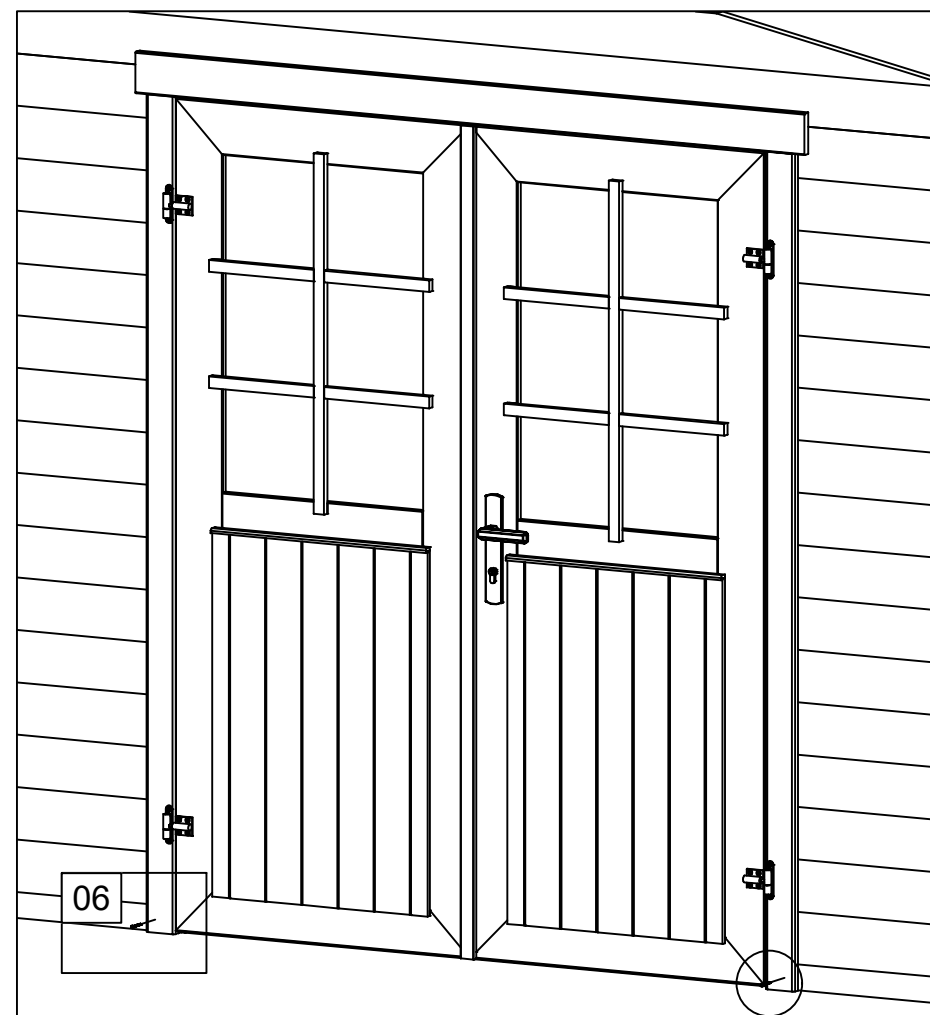
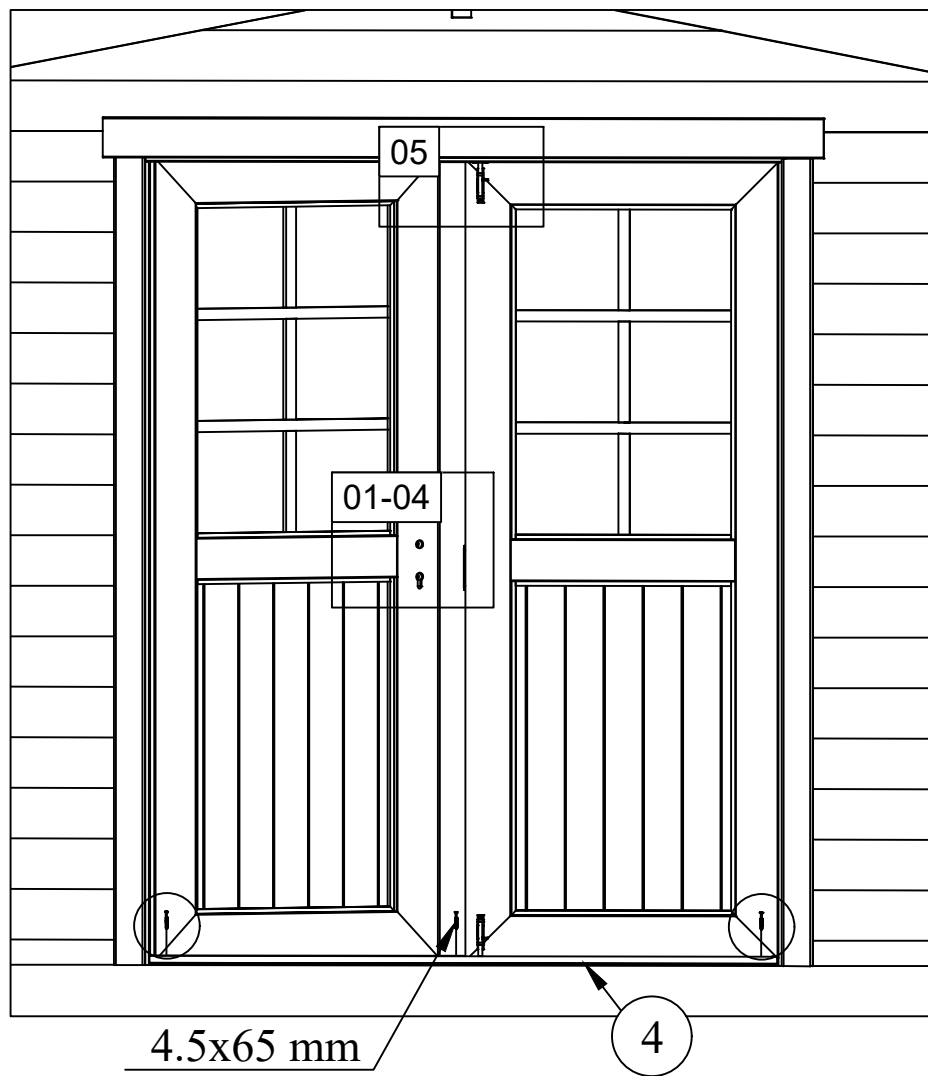

01

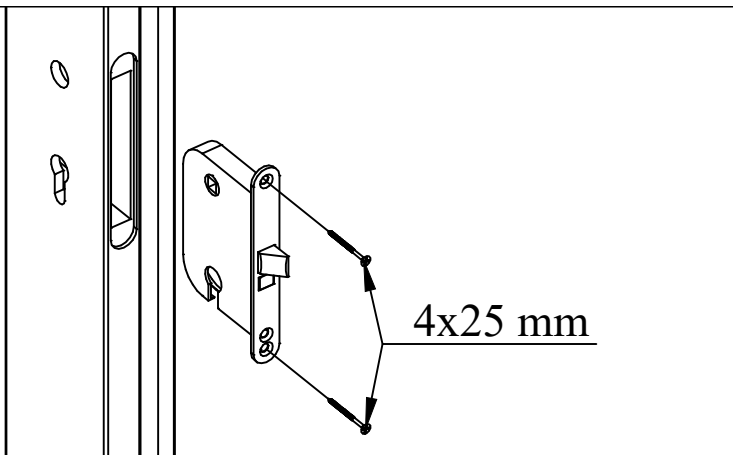

04

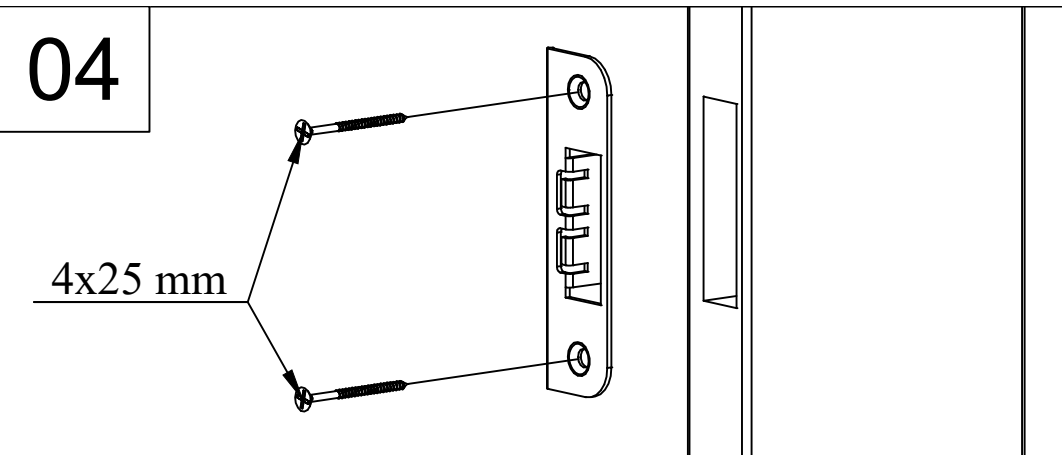

02

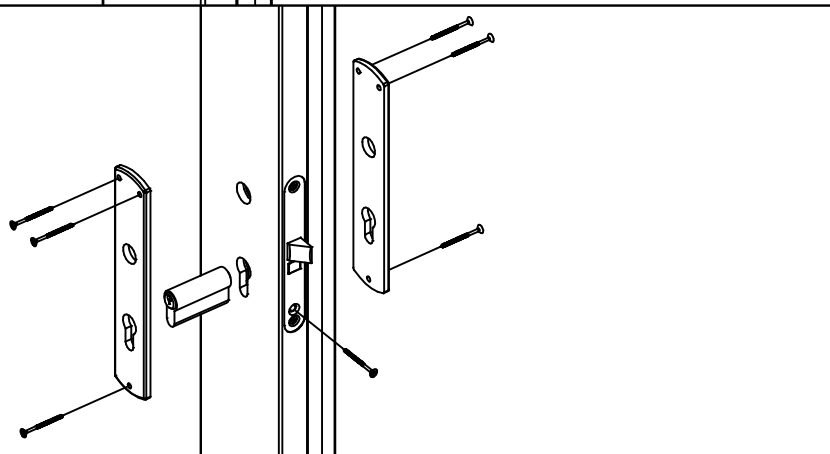

05

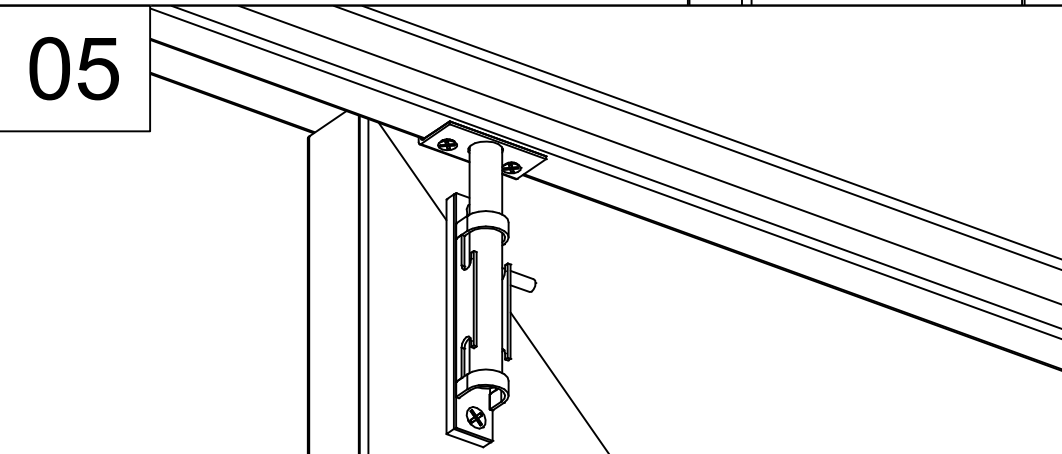

03

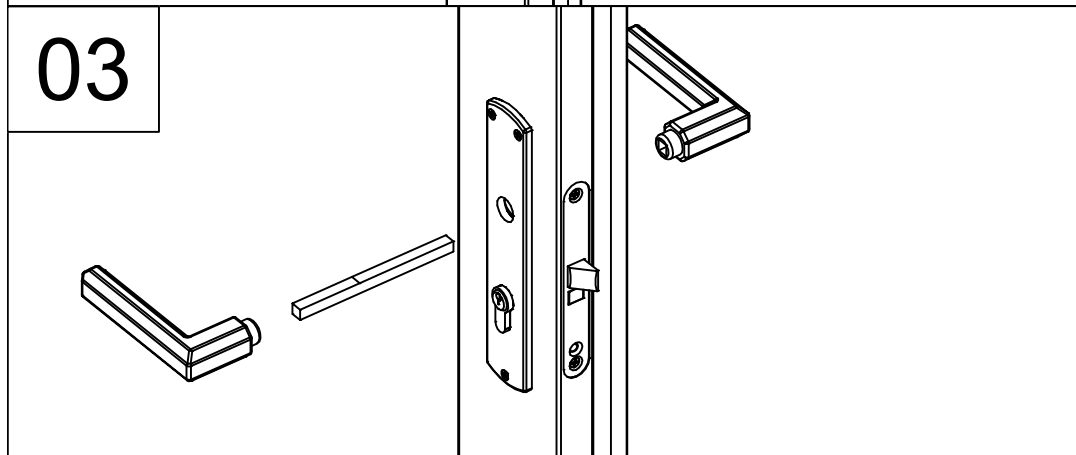

06

